



# Pro Dunk® Court Marking Stencil Kit User Manual

**Toll Free:** 1.888.600.8545

**Pro Dunk® Hoops**

**Web:** [www.produnkhoops.com](http://www.produnkhoops.com)

22047 Lutheran Church Rd.

**FAX:** (281) 357-4822

Tomball, TX 77377

## **What's Included In Your Court Marking Stencil Kit:**

- A Main Key
  - B Free Throw Line
  - C Bottom Key Blocks
  - D Key Hash Marks
  - E Fill In (Creates Solid Lines At The End Optional)
  - F 3 Point Line
  - H Line Width Guide
  - I Pro Dunk Logo
- Spray Box (Box The Stencil Comes In)  
Two Cans of Spray Paint  
Plum bob and String  
Roll of Masking Tape

## **Other Required Tools:**

**Before You Start:**

Preparation is very important for long lasting court lines. Your court area should be completely dry and free of any oil, grease, or dirt. Do not begin on a wet or windy day to ensure that the paint will have enough time to completely dry. Make sure you are within the operating temperatures by reading the spray paint can.

**Step 1:**

Install the plum bob by hanging it from the center of your backboard directly underneath the rim using the provided masking tape.

Hang so that the plum bob weight is just above the ground below the backboard. Place an X using the masking tape provided where the plum bob points on the ground.

NOTE: If your basketball system has backboard padding measure from the glass on the ground.

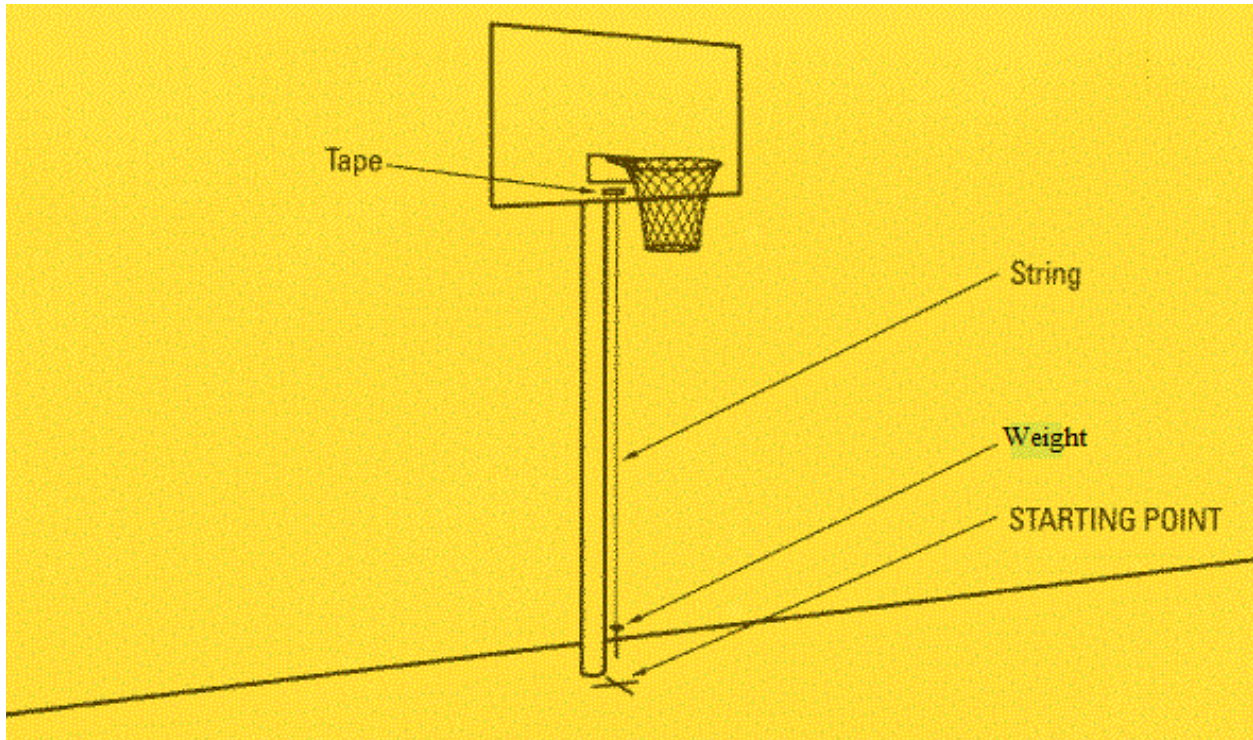

**Step 2:**

Using your tape measure find the center of the **H—Lane Width Guide** and center that up with your X mark under the backboard. Once centered and parallel with the backboard tape it down to the ground using the provided masking tape.

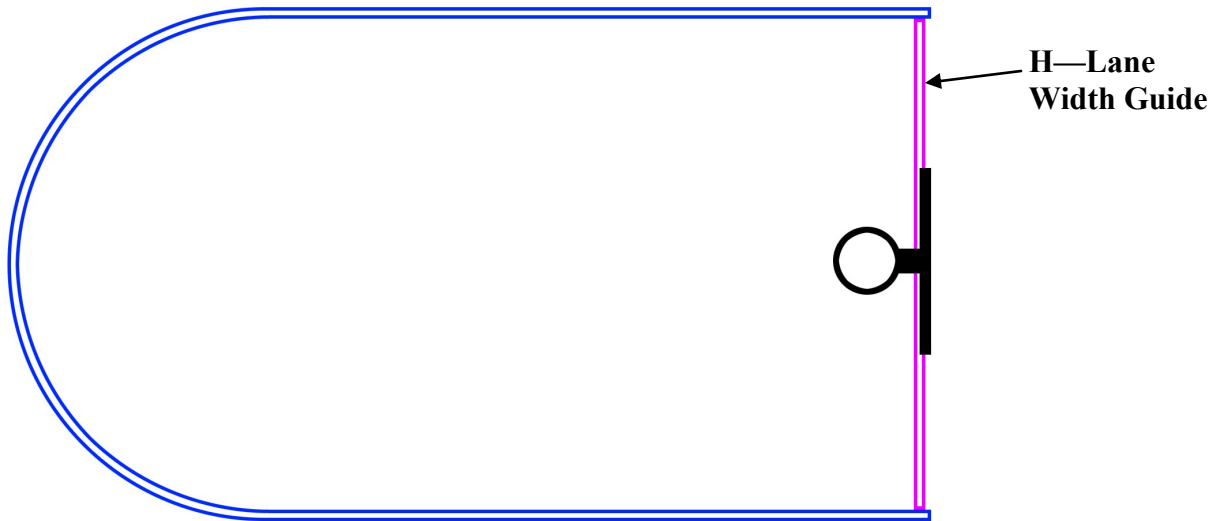

Fold out **A—Main Key** as shown below. On each end of **A—Main Key** there is a notch where **H—Lane Width Guide** will fit into. Place **A—Main Key** so that **H—Lane Width Guide** fits into the notch and then using the provided masking tape, tape the **H—Main Key** down to the ground securely.

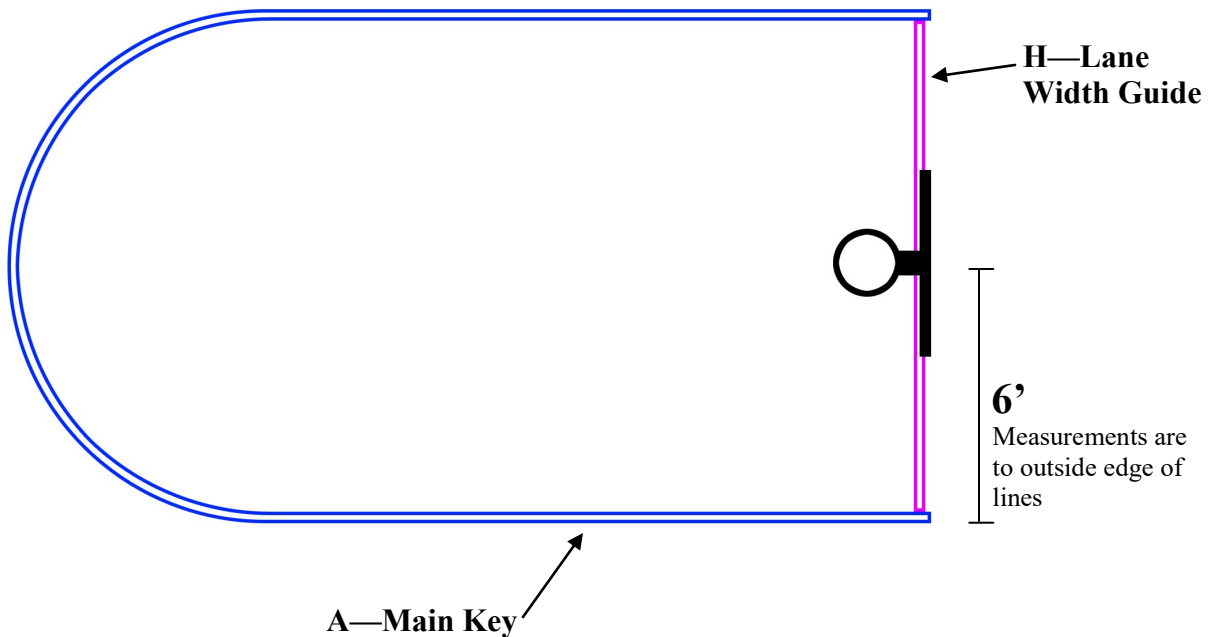

**Step 3:**

Fold out **B—Free Throw Line** and align it to the opening in the **A—Main Key**. Secure to the ground with masking tape.

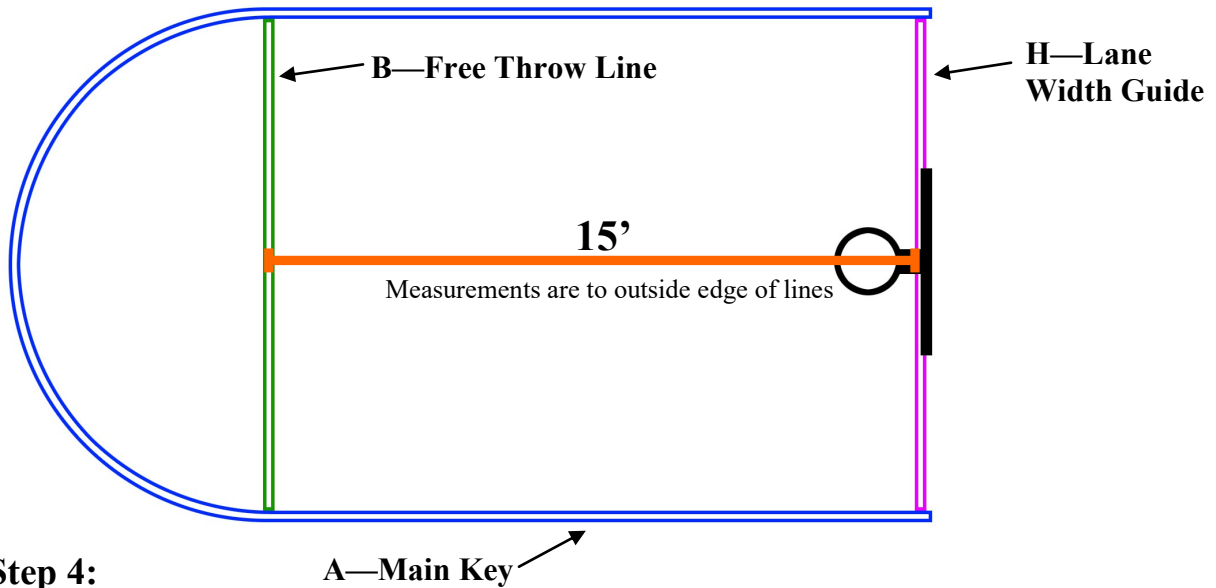

**Step 4:**

Fold out **F—3 Point Line** as shown below. This should overlap and be flush to the top of the **A—Main Key**. Secure to the ground with masking tape.

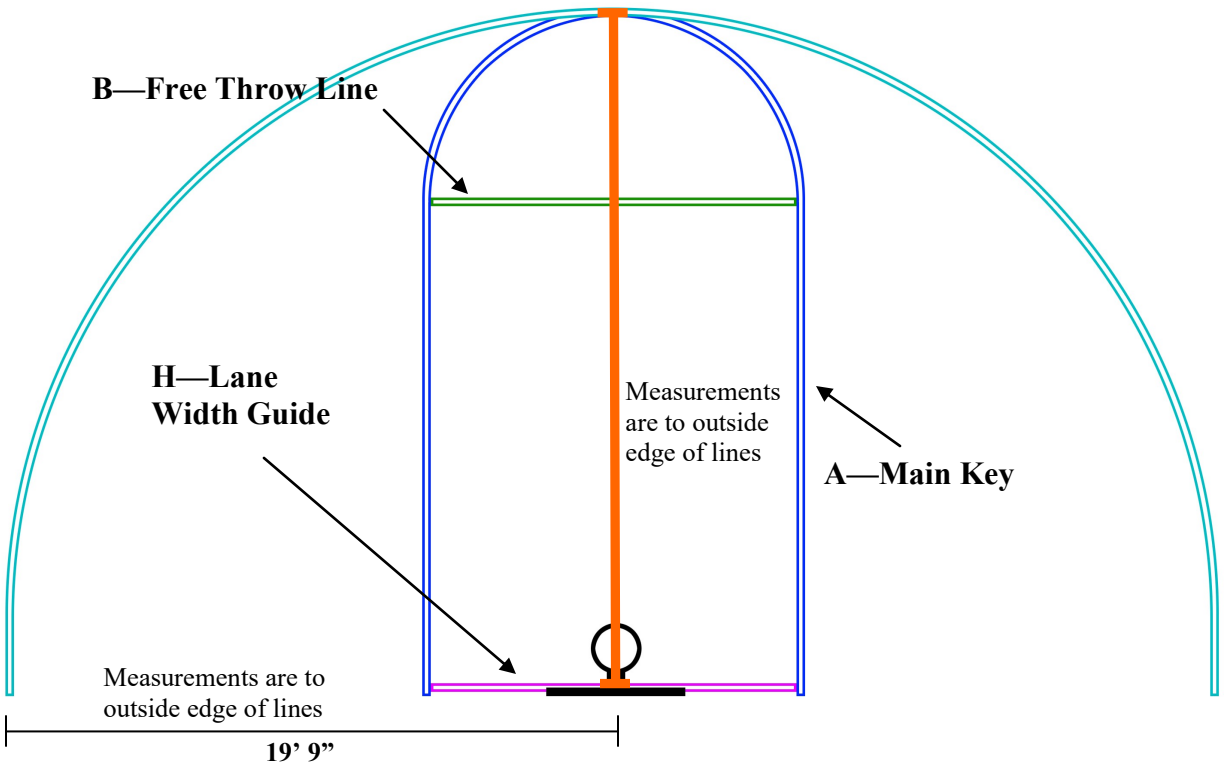



### Step 5:

Once steps 2-4 has been secured to the ground with the provided masking tape we will start the painting process.

First we will need to pull out the **Spray Box** which happens to be the same box the stencil is packed in. You will notice there is a perforated rectangle in the bottom of the box. You will want to remove this so that your box looks like the below photo.

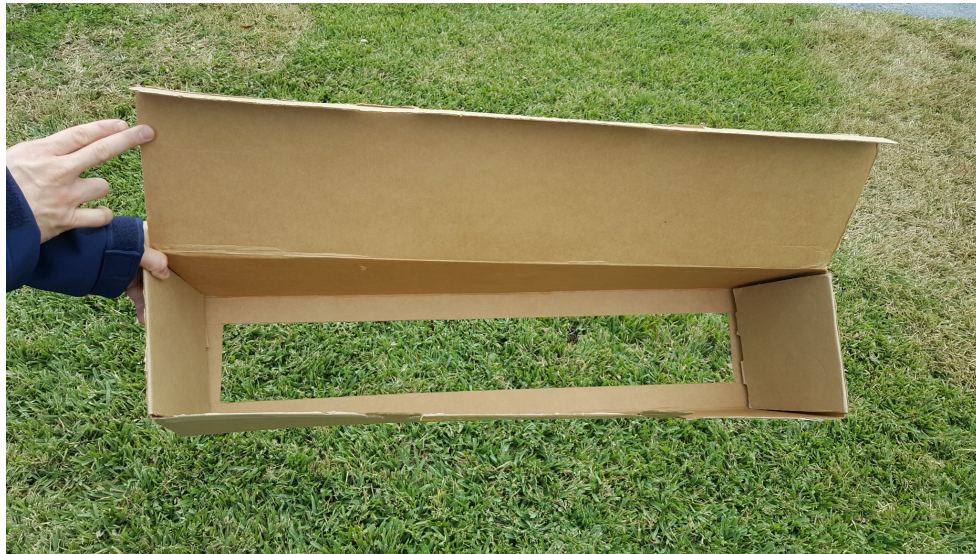

Then place the **Spray Box** along your stencil lines and start painting. This box will help you apply pressure to the stencil so that everything makes good contact with the ground and to keep you from over spraying onto your court area.



**Step 6:**

Once all of your lines have been painted let it fully dry for no less than 1 hour. Temperature and humidity will affect the drying time.

Once completely dry you will want to pull your stencil up and fold it back up for storage. Next place all of your **C—Bottom Key Blocks** and **D—Key Hash Marks** out like below. Secure each one with provided masking tape.

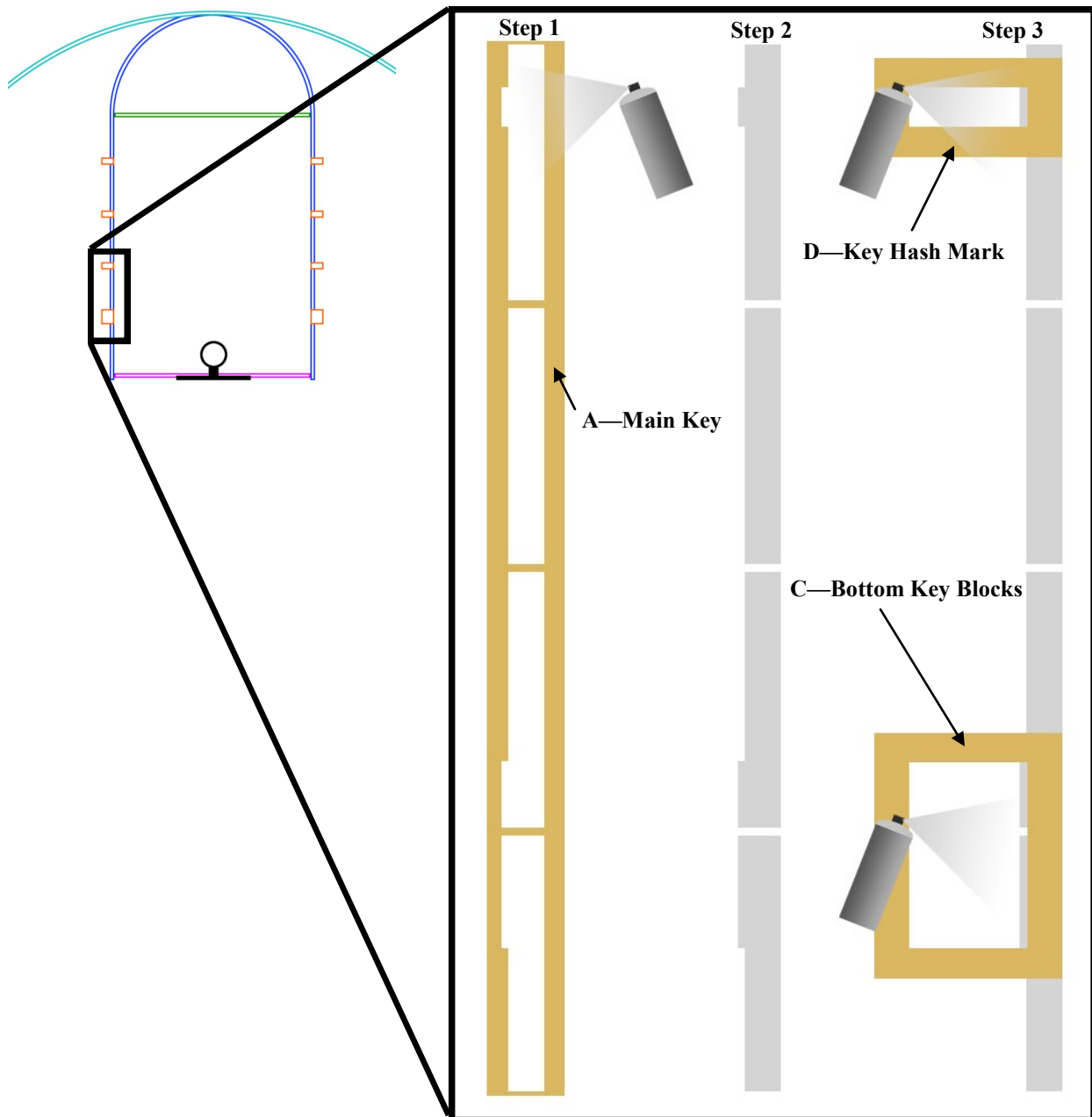

**Step 7:**

Once all of your blocks and hash marks have been painted let it fully dry for no less than 1 hour. Temperature and humidity will affect the drying time.

Once completely dry you will want to pull your stencil blocks and hash marks up.

This step is optional. If you would like to have solid lines you can use the **E—Fill In** to paint all of the dashes solid. Place the **E—Fill In** stencil over the dash line in step 2. Then place your **Spray Box** overtop and paint. Continue this until all dashes are filled in on your court.

**PRO TIP:** Tap the **E—Fill In** stencil to the bottom of your **Spray Box** to speed up the fill in process.

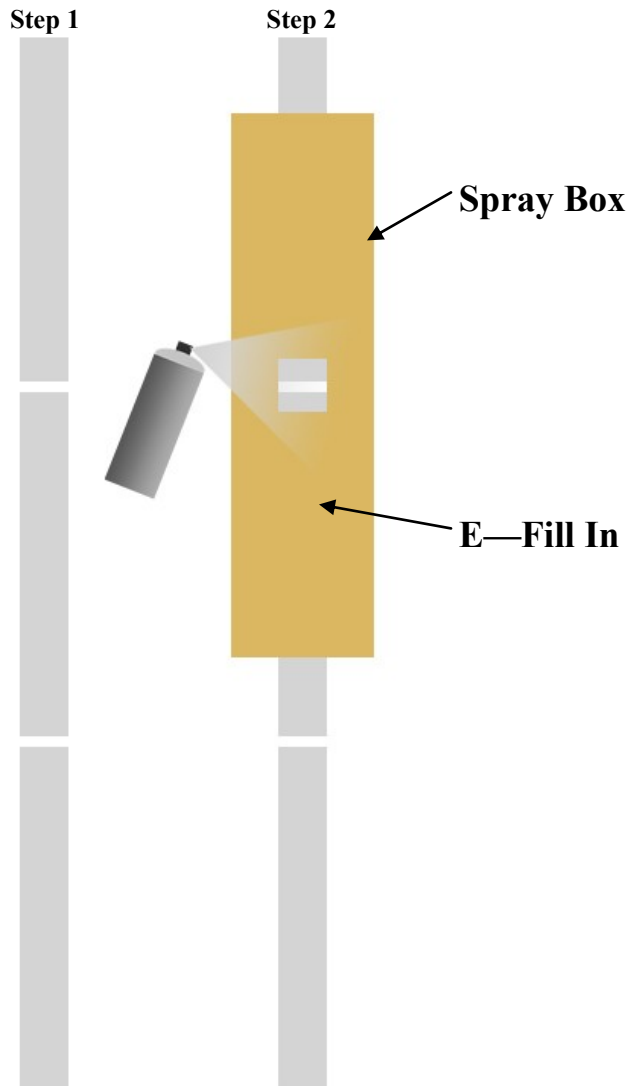

**Step 8:**

This step is optional. Painting the Pro Dunk LOGO on your court. You can get creative by using different color paints if you would like. Pick a location on your court like shown below and secure the **I—Pro Dunk LOGO** down using the provided masking tape. Then using the **Spray Box** fill in the stencil. Let completely dry before use.

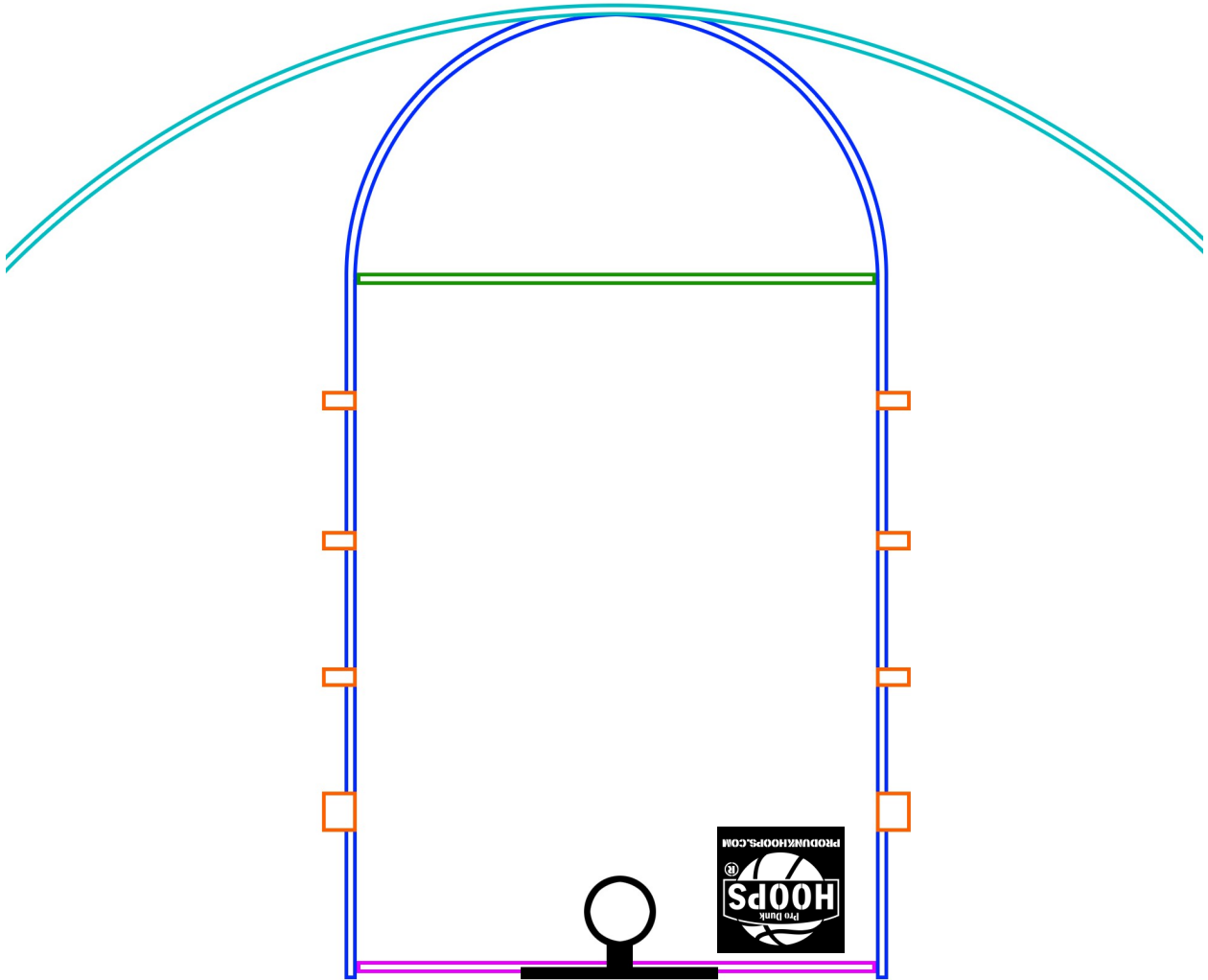

**Enjoy your new court!**